

Master your elements

Modular, flexible, adaptable.

Assembly tables from the BUILDTEQ series.



HC | WEINMANN





BUILDTEQ assembly tables

Versatile and future-proof

Assembly tables from the BUILDTEQ series enable you to easily manufacture wood frame construction elements with a high degree of dimensional accuracy. With these tables, we offer you solutions that can be integrated to optimum effect both in woodworking shops and in industrial production. They are suitable for a wide range of applications including manufacturing wall, roof, floor and gable elements. The higher level of prefabrication and the consistently high quality increase efficiency in your production operations.

YOUR SOLUTION

[MORE AT HOMAG.COM](https://www.homag.com)



BUILDTEQ SERIES

CONTENTS

- 4 Benefits of element production with an assembly table
- 6 BUILDTEQ assembly tables for woodworking shops
- 8 BUILDTEQ A-100
- 10 BUILDTEQ A-300
- 12 Extension options for BUILDTEQ A-100 and 300
- 14 Butterfly turning table
- 18 BUILDTEQ A-500
- 24 BUILDTEQ A-600
- 28 Control technology
- 29 Product range
- 30 Technical data
- 32 Life Cycle Services
- 34 Academy
- 36 SCHULER consulting package

Benefits of element production with an assembly table

The assembly tables from the BUILDTEQ series are ideal for the ergonomic and efficient manufacture of rectangular wood frame construction elements and can be extended on a modular basis.





THE BENEFITS AT A GLANCE:

Many companies still manufacture elements completely by hand and without additional aids. The BUILDTEQ assembly tables offer a variety of functions and extension options that simplify production sequences and processes and relieve the burden on your employees.

SAFE AND ERGONOMIC:

- Ergonomic working height
- Direct installation of all control elements on the table
- Safe work operations thanks to solid, non-slip sheathing

UNIVERSAL APPLICATION:

- Supports production of wall, roof, floor and gable elements
- Supports simultaneous manufacture of two elements on one assembly table thanks to two separate clamping circuits

POTENTIAL FOR MODULAR EXTENSION:

- The BUILDTEQ modular design creates potential to continuously increase capacity, even with the flat-pack table version
- Production processes can be optimized incrementally
- Extension options such as the butterfly turning table or the multifunction bridge are available to optimize production processes

IDEAL ENTRY-LEVEL OPTION FOR WOODWORKING SHOPS:

- Optimum solution for small and medium-sized enterprises
- Supports production of special elements such as gables, bays and knee walls

SUSTAINABLE THINKING:

- The installed profiles can be reutilized in the next expansion stage of the assembly table

BUILDTEQ assembly tables for woodworking shops

Ideal for your needs

The BUILDTEQ series is available in various designs for use in woodworking shops. Whether it's a flat-pack table, insert table or tilt table – there is a wide range of variants available to you.

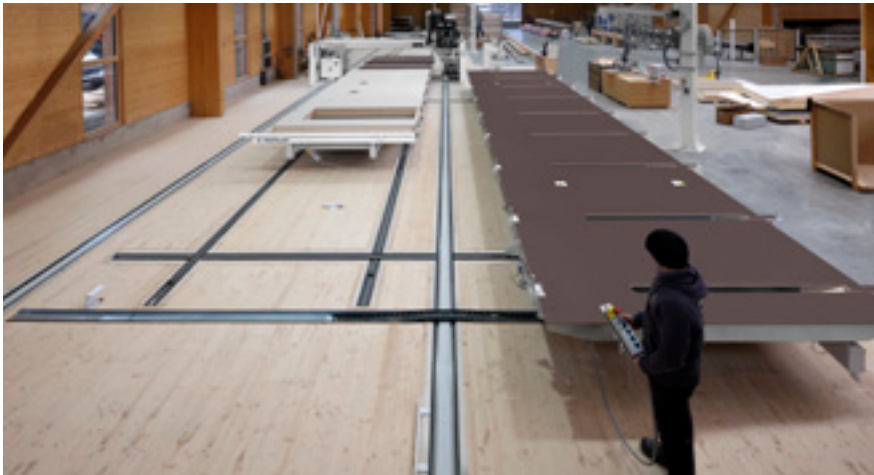

WELL-POSITIONED – EVEN WITH THE STANDARD FEATURES

Even the standard features of the BUILDTEQ assembly tables incorporate useful details that make your everyday work much easier. The sturdy design allows heavy and complex elements to be processed. Elements with a weight of up to 3.5 tons can be manufactured with the standard features.



C-POWERTEC CLAMPING BEAMS

Automated frame work clamping means that elements can be manufactured with more ease and at greater speed.

- Reduced manufacturing times: The plate and stud are clamped without any gaps and can be joined immediately using nails
- Variety of elements: Pneumatic clamping beams with extensions allow production of elements up to 3.8 m wide, for use in commercial construction, for example
- High level of quality: A precise horizontal position is guaranteed, even at full extension



X STOP

Elements can be aligned at the correct angle at the X stop.

- Precise assembly thanks to exact alignment at an angle of 90°
- Elements can be aligned either at stop pins or at a continuous stop profile

TWO CLAMPING CIRCUITS

Simultaneous manufacture of two elements on one work table.

- Separate clamping circuits mean that two elements can be clamped
- Available for all assembly tables from a length of 8 m



BUILDTEQ A-100 flat-pack table

We provide the technology, you provide the wood.

We combine our core expertise with yours to offer you a simple yet powerful solution for a reduced budget. This allows you to bring the BUILDTEQ to life yourself with the help of our technology, our framing program and your resources.

To make it easy for you to set up the assembly table, WEINMANN provides you with easy-to-understand assembly instructions, the required technology and a video guide so that you can make full use of the BUILDTEQ A-100. All required components, such as the pneumatic unit and clamping profiles, are included in the scope of delivery and clearly marked.

You provide the wood for the substructure. The subsequent setup process can then be performed quickly and easily.

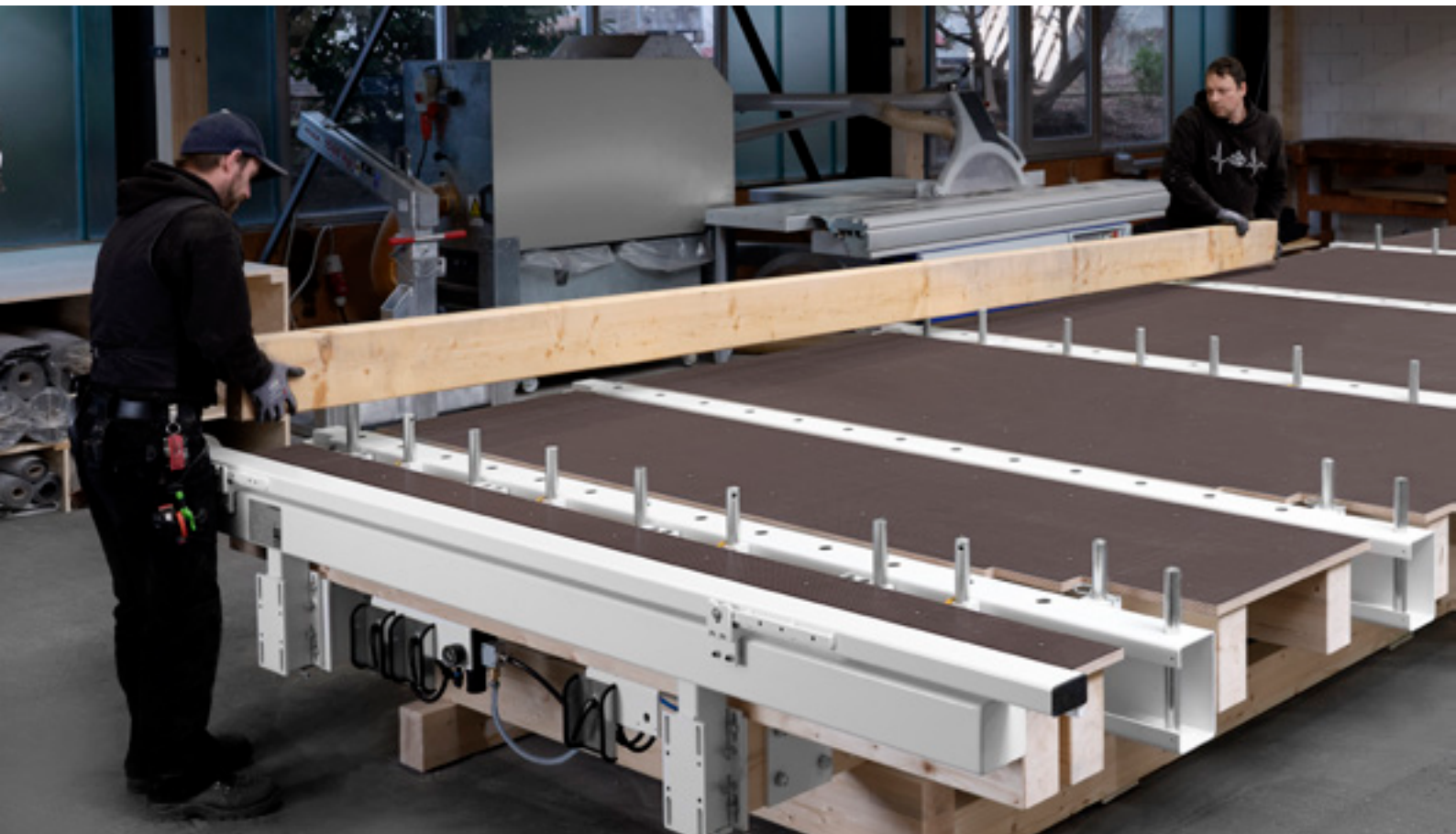

HIGH-QUALITY EQUIPMENT:

- C-PowerTec clamping beams
- Precise angled stop system
- Pneumatics systems for the central air supply and control of the C-PowerTec clamping beams
- Fixtures for connecting to the table base frame
- Detailed assembly instructions
- Optional roof/ceiling clamping units
- Two separate clamping circuits for clamping two elements



PRACTICAL APPLICATION OPTIONS

- Universal application for wall, roof and floor elements in wood frame construction
- Can be extended with modules to make a carpentry table or combined with a multifunction bridge

BUILDTEQ A-300 carpentry table

Universal application

These carpentry tables are ideally suited to manufacturing wall, gable, roof and floor elements, as well as frame walls and roof dormers. The integrated technology guarantees a high level of dimensional and angular accuracy. Extension to include optional features supports adaptation to your individual requirements. The integration of chassis and hydraulic tilt functions also enables you to turn elements with ease.



FUNCTIONAL DETAILS:

- Clamping system: The automated clamping system enables frame work to be manufactured quickly and easily
- X and Y stops: X and Y stops allow for alignment at the correct angles
- Element ejector: Optional for turning roof/floor elements. An integrated element ejector pushes the element out of the clamping units pneumatically during the turning operation
- Chassis: Chassis in the longitudinal and transverse direction enable adapted element positioning, as well as the combination of several assembly tables in one production system
- (Option) Integrated hydraulics: The carpentry table tilts itself to turn the elements. This allows the element to be removed, rotated and repositioned using the overhead crane



Extension options

BUILDTEQ A-100 and BUILDTEQ A-300

ROOF/CEILING CLAMPS:

The roof rafters and beams are inserted into the opened clamps and fixed in place. When the manual slide valve is closed, the beams are correctly aligned and tensioned. This also corrects slight twists. The stop point is defined separately for each beam, allowing a high degree of dimensional accuracy to be achieved regardless of the dimensions of the individual beam.

- Each beam is clamped individually
- The clamping pairs can be fixed in place anywhere on the beam
- Precise positioning using measuring tapes
- Optional: Individual roof/ceiling clamps or roof/ceiling clamp package (12 units)

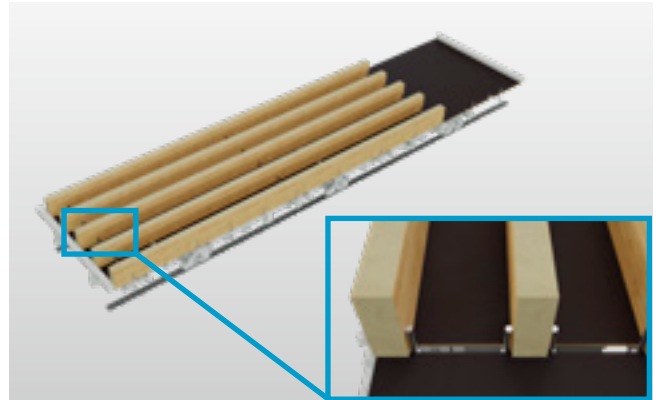

MEASURING TAPE:

Aid for more precise positioning of wood or clamping devices. The measuring tape arranged in the transverse direction is an aid that enables more precise positioning of wood or clamping devices. Available in both metric and imperial versions.



PNEUMATIC AND ELECTRICAL CONNECTION OPTIONS:

Enables the use of handheld units through connections on the longitudinal side of the table.



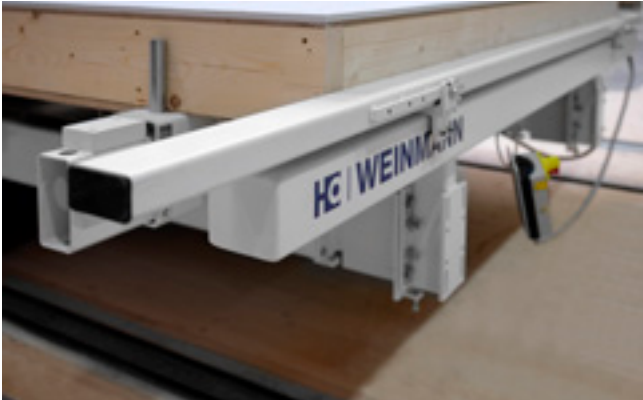

CONTINUOUS X STOP:

Precise alignment of roof and floor elements. The universal stop pipe is 3.2 m long.



UNIVERSAL CLAMPS:

For clamping the top and bottom plates, as well as studs, spandrels and diagonal gable timber. The clamp can be positioned individually on the profiles.



SECOND X STOP:

Enables simultaneous alignment of two elements on one assembly table. Both elements are aligned simultaneously with the second X stop.



DIFFERENT PIN LENGTHS AND HEIGHT-ADJUSTABLE PINS:

Stop pins for correct alignment and safe turning. The pins are suitable for different element thicknesses.

Butterfly turning table

Turning in a single movement

The WEINMANN butterfly turning tables offer you the ideal solution for turning elements. Two assembly tables move to positions opposite each other. The element is then transferred from one table to another during tilting. The entire turning operation is performed exclusively with the two assembly tables; no overhead crane is required.

The entire operation is completed in just 90 seconds. This process also significantly increases the level of work safety and reduces the risk of damage to the element. The two assembly tables also serve as two separate workstations on which work can be performed in parallel.



PRODUCE CLOSED ELEMENTS — EFFICIENTLY AND EASILY

The frame work is created on the feeder table. The sheathing is then placed on top and secured. The hydraulic system on the tables means that the feeder table can be tilted to transfer the element to the receiving table. The receiving table also has a chassis and moves parallel to the feeder table. The receiving table tilts opposite the feeder table and takes over the element. After the turning operation, plumbing and electrical installations are installed using the receiving table and the insulation is attached. The second side of the element is then closed and secured. This means that with just two people, you can achieve a capacity of up to 30 houses per year.



FAST AND SAFE TURNING OPERATION:

- Faster turning process — within just 90 seconds
- Safe turning operation that protects the workpiece without the use of a crane
- Ergonomic work sequence thanks to short distances and optimum heights
- Simplified handling
- Optimized space

PARALLEL BUTTERFLY TURNING TABLES — THE ENTRY-LEVEL SOLUTION

In this system, the receiving table has a chassis in the transverse direction, allowing parallel movement into various positions. The position of the assembly table can thus be adjusted so that employees have enough space to work on both tables. Parallel movement also means that elements of different thicknesses can be turned. The sensors installed specify the corresponding position for the turning operation to the feeder table. The parallel butterfly turning table requires a hall space of just 12 x 7 m to manufacture 12-m elements.

LONGITUDINAL/TRANSVERSE BUTTERFLY TURNING TABLES — EXPANDABLE AND ADAPTABLE

On longitudinal/transverse butterfly turning tables, the feeder table also has a chassis in the longitudinal direction. Both assembly tables are positioned in a line and can be moved to the corresponding position as required. The feeder table moves in the longitudinal direction and the receiving table moves in the transverse direction. This system is suitable for combination with a multifunction bridge, and can therefore be expanded later to form a compact system. The defined production sequence optimizes material logistics and increases productivity.



WEINMANN
Butterfly turning table

	PARALLEL BUTTERFLY TURNING TABLE	LONGITUDINAL/TRANSVERSE BUTTERFLY TURNING TABLE
	Entry-level solution	Expandable and adaptable
Hydraulic swivel device	x	x
Full-surface sheathing	x	x
Transverse chassis	x	x
Combination of longitudinal and transverse chassis	-	x
Can be expanded with the addition of a multifunction bridge	-	x
Individually configurable	-	x
Space requirement for 12-m tables	Approx. 100 m ²	Approx. 153 m ²

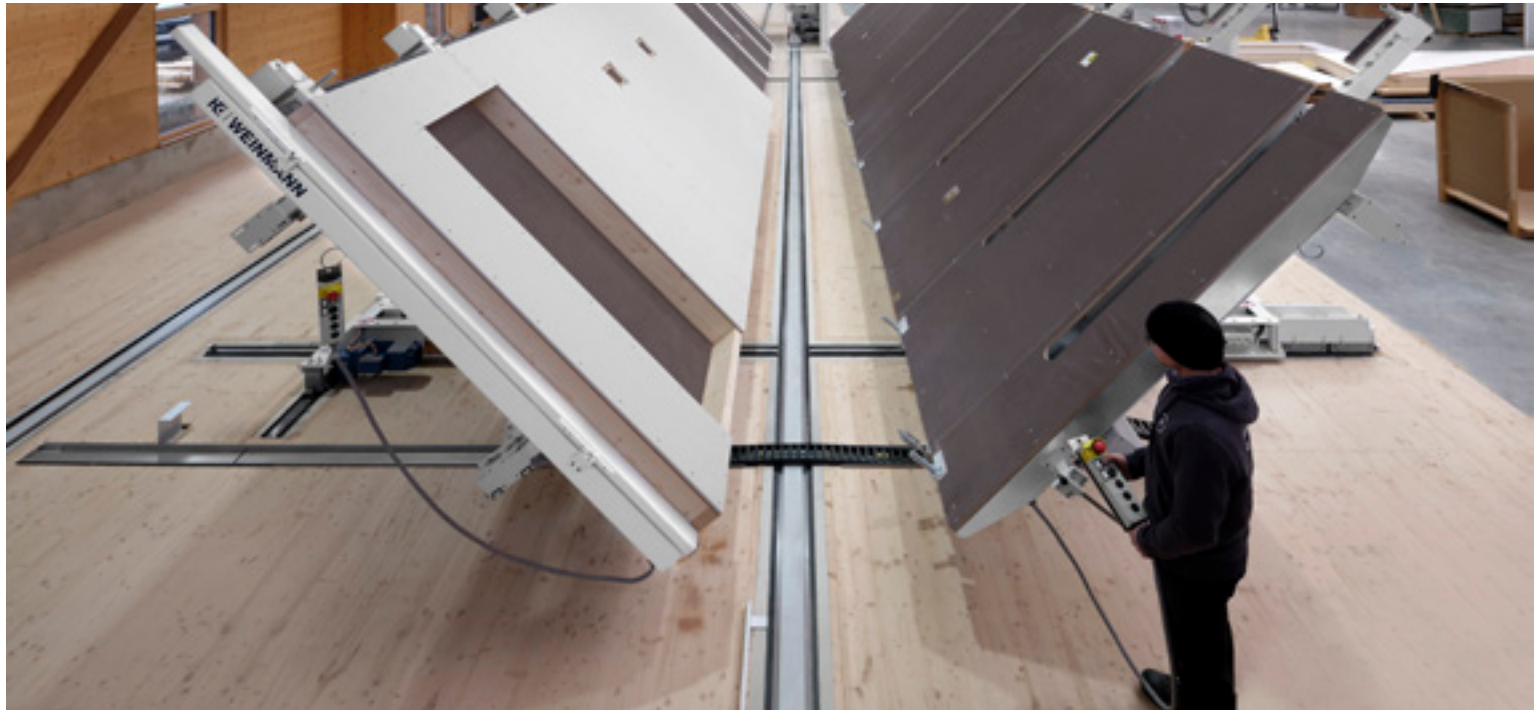

BUILDTEQ A-500 element table

Flexible in industrial production

The BUILDTEQ series element tables are truly versatile components in the production line and take over tasks such as turning elements, aligning elements at the correct angle to ensure safe sheathing and processing, transport and tilting for storage.

You can customize the configuration of the BUILDTEQ A-500 to suit your production situation. The benefit for you: if your capacity output increases, your assembly table grows with you. Thanks to the wide range of extension options, the table can be expanded at any time and adapted to higher levels of automation.





TRANSPORT USING ROLLER STRIPS

Roller strips are used for manual transport of elements in the longitudinal direction.



OPTION: PLASTER PACKAGE

Rubber rollers, specially designed for manufacturing elements with plaster sheathing, are fitted to the infeed side of the table.



AUTOMATIC ELEMENT DETECTION AT THE X STOP

The infeed transport is slowed down, ensuring that the element is not damaged during the operation.



MOTORIZED ELEMENT TRANSPORT

Three hinged slat conveyors and roller conveyors on the bottom plate.

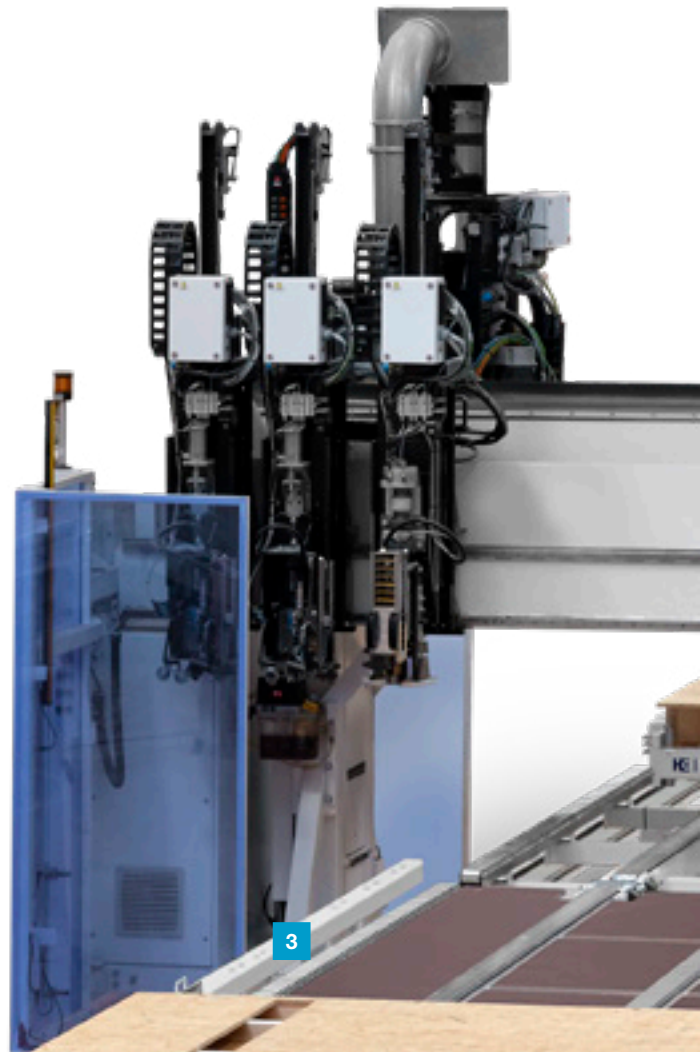



1 X STOP CAN BE LOWERED PNEUMATICALLY

Elements are aligned at the correct angle.

2 OPTION: PNEUMATIC MAIN CLAMP

The element is aligned and fixed in place so that the sheathing can be attached and secured.

3 Y STOP

Elements are aligned at the correct angle.





BOTTOM PLATE CLAMP IN Y DIRECTION

Open elements can be clamped securely regardless of the wall height. This requires no additional setup time at the table.



NC-CONTROLLED STUD ALIGNER IN X DIRECTION

Ensures high precision.

BUILDTEQ A-600 roof and floor table

Specialist for roof and floor elements

The BUILDTEQ A-600 enables roof and floor elements to be manufactured quickly and easily. The result is completely rectangular and correctly mounted elements. Using the NC-controlled clamping system, the beam positions are specified automatically based on the CAD data and the beams are clamped. If the table is integrated into a production line, the elements can also be transported, installed and turned. The fully automated setup process for the table is performed only during non-productive time, meaning that there is no waiting time between two elements.

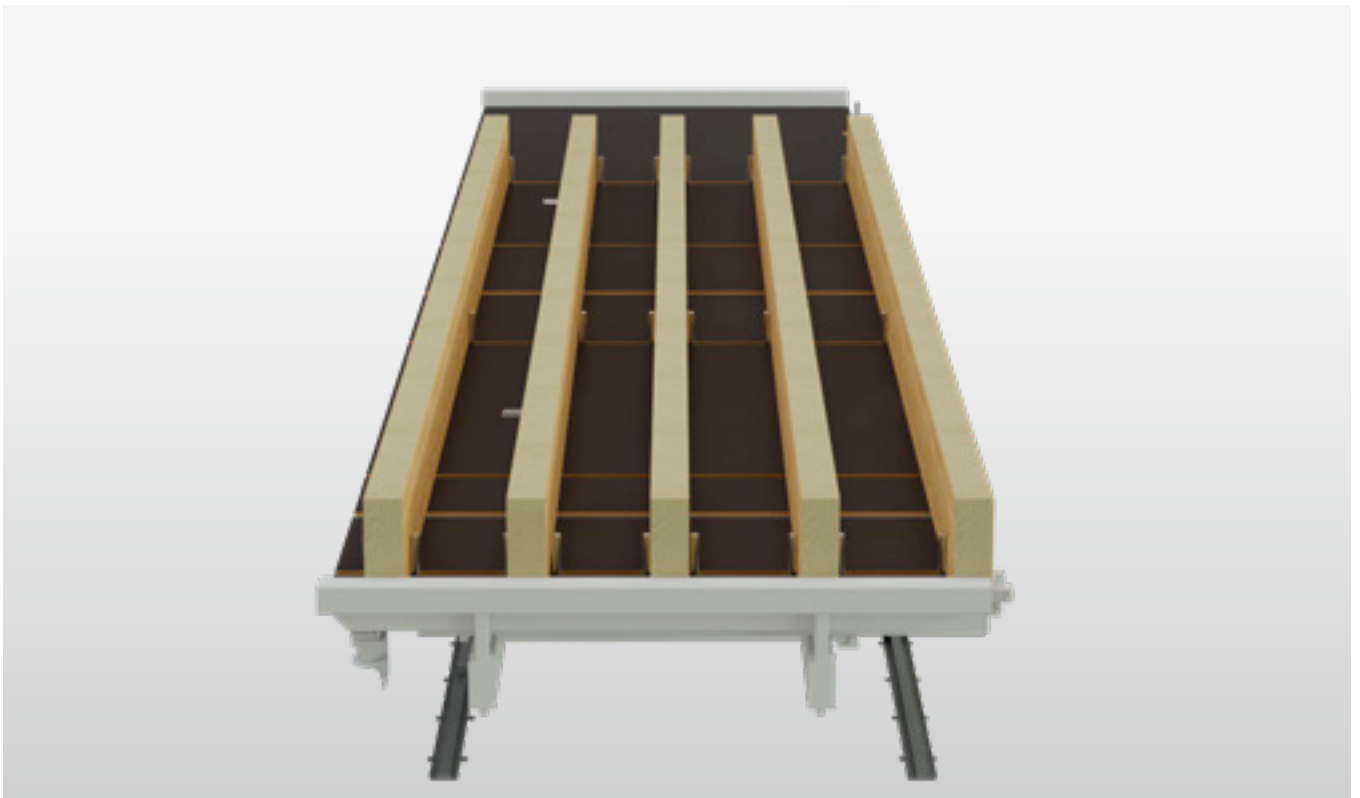
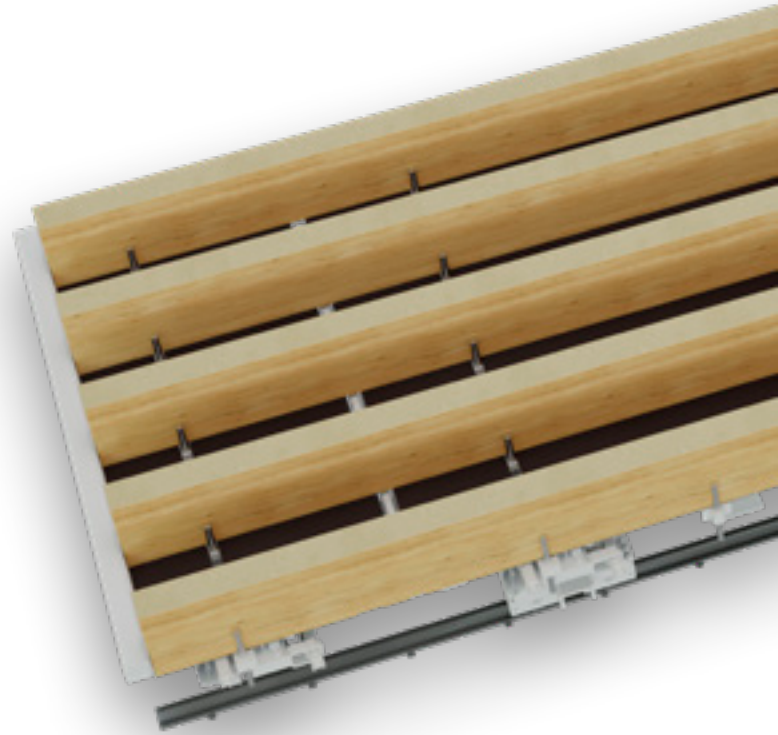



Standard feature(s)

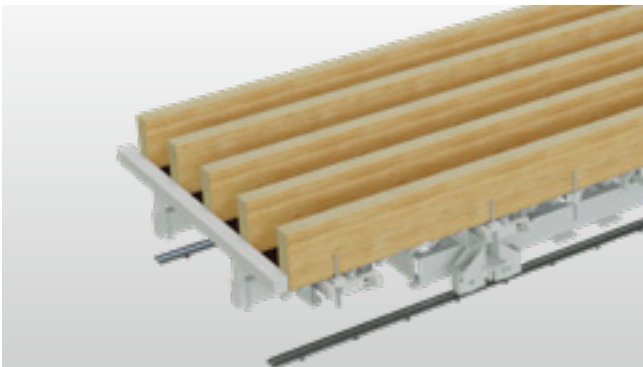

X STOP

Manufacture rectangular elements with the X stop.

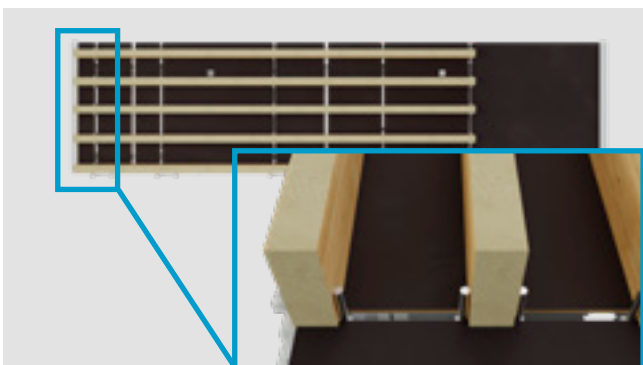

NC-CONTROLLED CLAMPING SYSTEM

Enables fully automatic clamping and alignment of beams.

- Up to six individual beams can be clamped
- Suitable for beam widths from 50–170 mm
- NC axes allow precise positioning of beams
- NC-controlled clamping system with clamping optimization:
Synchronous creation of clamping pairs for the complete beam layer in a very short time

Options

HYDRAULIC TILT FUNCTION

Tilting and turning of the elements.



INTEGRATED ELEMENT EJECTOR

The element is pneumatically pushed out of the clamping units during the turning operation.

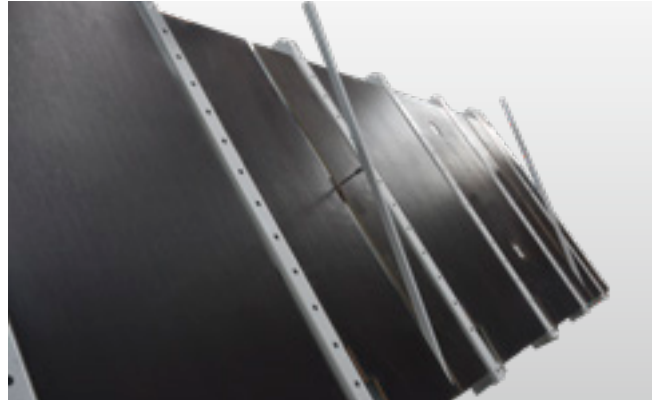

LONGITUDINAL/TRANSVERSE CHASSIS

Chassis in the longitudinal or transverse direction enable integration in a production line.

1 Transverse direction

2 Longitudinal direction



Software

The wupWorks 3 software automatically converts WUP files created in a CAD program into CNC programs. The corresponding data is displayed graphically as a 3D model. Work preparation is optimized with the wupWorks Office and wupEditor Office software packages. The woodScout diagnostic system enables systematic troubleshooting and increases machine availability. The MMR Basic, Professional and Office software module can also be used. The BUILDTEQ A-600 is also tapio-ready. The entire clamping system is actuated automatically using the Homatic PLC system PC23Li. The NC-controlled units clamp and position the axes and clamping pairs fully automatically.

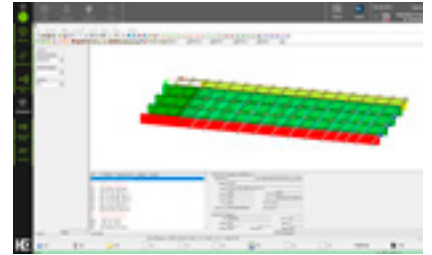

Control technology for assembly tables in industrial production

BUILDTEQ A-600 element tables are equipped with special control concepts. These allow the clamps, stops, chassis, hydraulics as well as the turning and transport operations to be actuated automatically. When the element tables are used in production lines, they are fully interlinked.

Various operating concepts/systems



Local control panel
With complete control system.



**Pendant control panel
(attached to the table flexibly)**
The control system is integrated into the table.

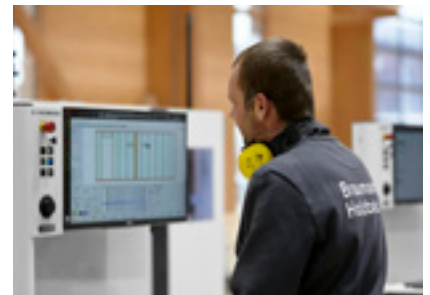

Via wupWorks 3
The CAD data is converted fully automatically and transferred to the machine.

CONTROL SYSTEM FOR THE PARALLEL BUTTERFLY TURNING TABLE

- A fixed control panel beneath the X stop
- Two movable pendant control panels on the tables for the turning operation

CONTROL SYSTEM FOR THE LONGITUDINAL/TRANSVERSE BUTTERFLY TURNING TABLE

- Fixed control panel with a view of the tables
- Additional decentralized control panel for controlling the travel functions
- Two movable pendant control panels on the tables for the turning operation

PRODUCTION LINE CONTROL SYSTEM

- For production lines with a maximum of six element tables and complex requirements
- Division into different control circuits possible
- Option to connect data records
- All standard functions such as clamp, stop, chassis, hydraulics, turning and transport can be controlled
- Extended diagnostic options: Own remote diagnostics
- tapio-ready

Highlights

- All machines are interlinked, which simplifies operation
- The safety systems are also interlinked, ensuring an extremely safe working environment
- Control of the turning and travel functions
- The function sequences are automated, and all functions can also be controlled individually
- Identical control over all tables and other WEINMANN products
- Standard online remote diagnostics possible

Product range

BUILDTEQ A-100

Assembly table as a flat-pack solution: We provide you with easy-to-understand assembly instructions, the required technology and a video guide. This allows you to set up the table yourself in no time. Ideal as an entry-level solution.

BUILDTEQ A-300

Insert table for universal application for all wood frame elements. Can be individually supplemented with a wide range of options. Very well suited for small and medium-sized carpentry businesses.

BUILDTEQ A-500

Element table with integrated transport system, which is ideal for use in production lines thanks to its flexible and customizable configuration options.

BUILDTEQ A-600

Special table for roof and floor production with NC-controlled clamping system. The table uses CAD data to specify the position of the beams fully automatically and clamps them securely.



OPTION:

BUILDTEQ A-500 compatible with WEINMANN Wall Storage Systems

Technical data

Assembly tables for woodworking shops

TABLE DIMENSIONS	BUILDTEQ A-100	BUILDTEQ A-300
1 Length (m)	6.2/8.3/10.1/12.1	6.2/8.2 /10.2/12.2
2 Width (m)	3	Customer-specific
3 Processing height (m)	Customer-specific	Customer-specific
Clamping range (m)	0.4-3.8	0.4 - 3.8
Sheathed clamping range (m)	0.4-2.6	0.4 - 3.8
Weight approx. (t)	0.6/0.7/0.8/1	Customer-specific

PRODUCT DIMENSIONS	BUILDTEQ A-100	BUILDTEQ A-300
Min. element length (m)	Variable	2
Max. element length (m)	6/8/10/12	6/8/10/12
Min. element width (m)	0.4	0.4
Max. element width (m)	3.8	3.8
Max. element weight (t)	3.5	3.5

BUILDTEQ A-300

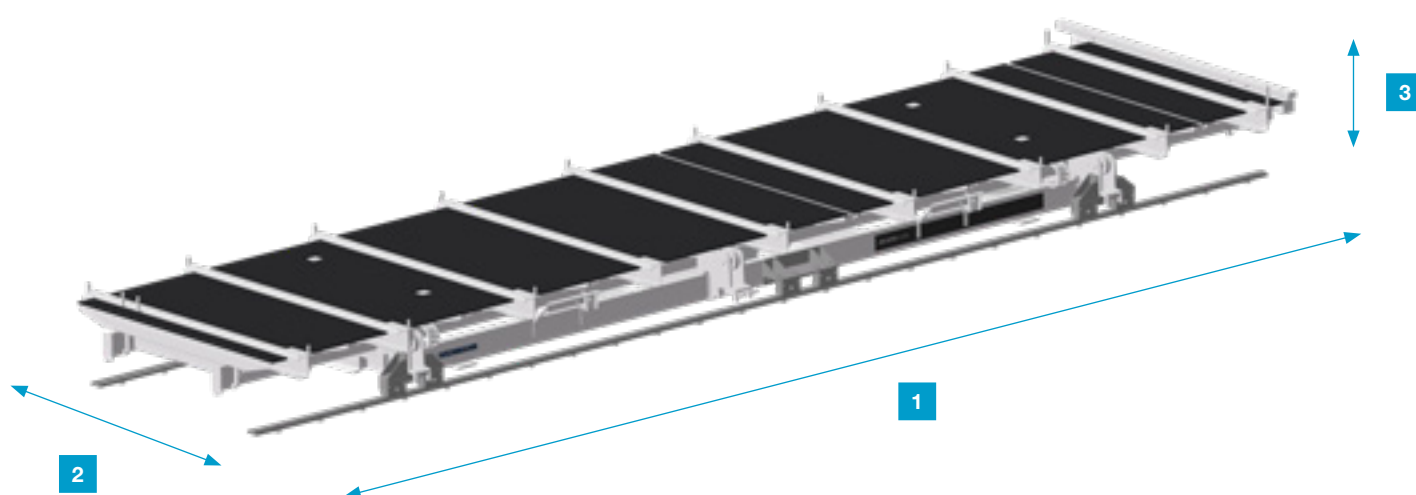
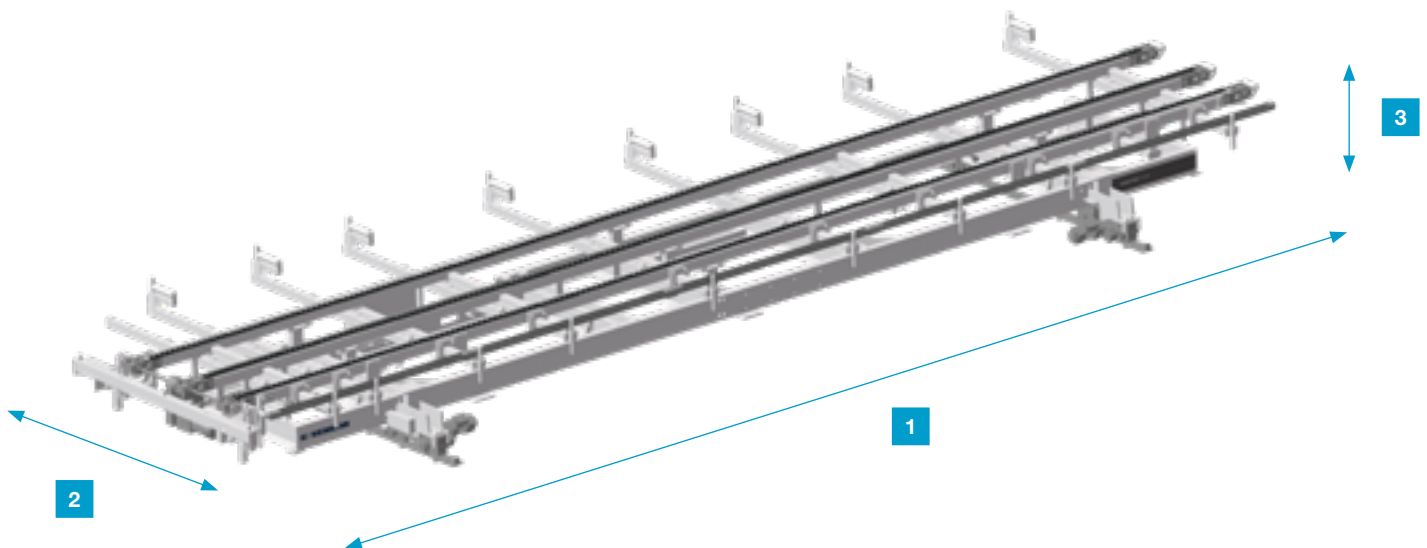

TABLE DIMENSIONS	BUILDTEQ A-500	BUILDTEQ A-600
1 Length (m)	6.2/8.2/10.2/12.2	
2 Width (m)	3.4	3
3 Processing height (m)	0.7	
Clamping range (m)	1.2–3.2 Optionally up to 3.8	0.6–2.6 Optionally up to 3
Sheathed clamping range (m)	Optional	Up to 3
Weight approx. (t)	Customer-specific	5.5/6/6.5/7

PRODUCT DIMENSIONS	BUILDTEQ A-500	BUILDTEQ A-600
Min. element length (m)	2	2
Max. element length (m)	6/8/10/12	
Min. element width (m)	1.2	0.6
Max. element width (m)	3.2 optionally up to 3.8	3
Max. element weight (t)	3.5	3.5

BUILDTEQ A-500



VALYOU

Our Mission, Your Performance.

LIFE CYCLE SERVICES

Improved performance, more efficient processes, faster help, assurance of availability and smarter working

TEAM & COVERAGE

Largest global service network in the industry with over 1,350 personnel.

INSTALLATION & COMMISSIONING

For a smooth start, we only let proven experts manage your setup.

OPERATION & CONTROL

After teaching your personnel the intuitive control system, our clever apps help to make the operator's life much easier.

MAINTENANCE & SERVICING

To keep things running, we're happy to take a preventative approach. You decide how often and how intensively you want the support to be. As we all know, prevention is better than the cure.

eSHOP & ONLINE ADVANTAGE

A few clicks and it's fixed. Receive exclusive advantages by ordering spare parts online, depending on market availability. shop.homag.com

HOTLINE & READINESS

When there's an emergency, we're here. Direct by phone, digitally via app or video, or with on-site support. We are close to you with over 90 regional service organizations worldwide. With more than 35,000 spare parts immediately available, we can deliver 85% of your orders fast.

TRAINING & EDUCATION

With classroom, live online or eLearning training, we offer flexible options to help you get knowledge. We conduct over 4,000 customer training courses every year, and we even have our own training centers in 19 countries

MODERNIZATION & IMPROVEMENT

Our modernization program is tailored to your machines and processes. We can evaluate your data and situation and advise you on the next step.

ANALYSIS & SUSTAINABILITY

On request, we analyze all your processes with proven tools and procedures (LeanSixSigma). We have a large, certified team of experts for this purpose.

FINANCING & CONSULTING

We offer you tailor-made financing concepts worldwide. With more than 60 years of experience and a close partner network of prominent banks and insurance companies to help us to find the right solution for you, we're always transparent and reliable in processing.



Fast support:
94% resolution rate
via our hotline

Close to you:
1,350 service experts worldwide

We get things moving:
Over 1,000 worldwide spare parts
shipments each day

No one else has that:
Electronic documentation on over
150,000 machines, available in 28
languages

The WEINMANN ACADEMY

With our help, you can simply be better than the rest.

Maximum productivity requires technological and trade expertise. The best way to increase your operational efficiency and output is through optimally trained employees. In addition to training courses for your new machine or software, we also offer further training and qualifications. We are constantly developing our training courses further and tailor them individually to your requirements – so you are optimally prepared for current and future challenges.

PREPARATION



PRODUCTION START

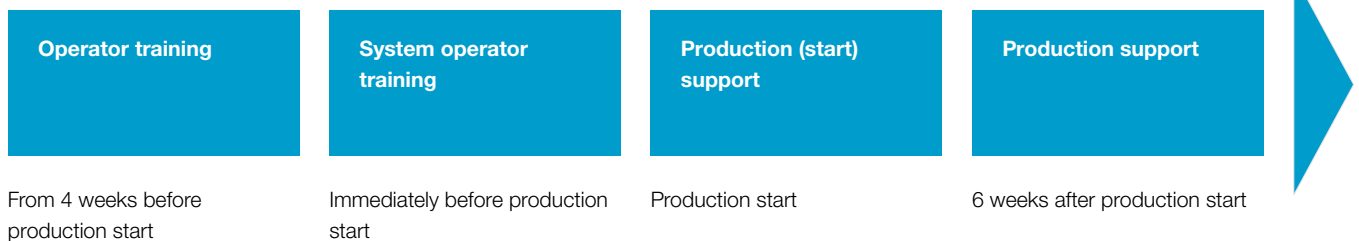

FOLLOW-UP



- Customer service
- CAD manufacturer offer
- WEINMANN Academy offer



WEINMANN Academy
Learn more

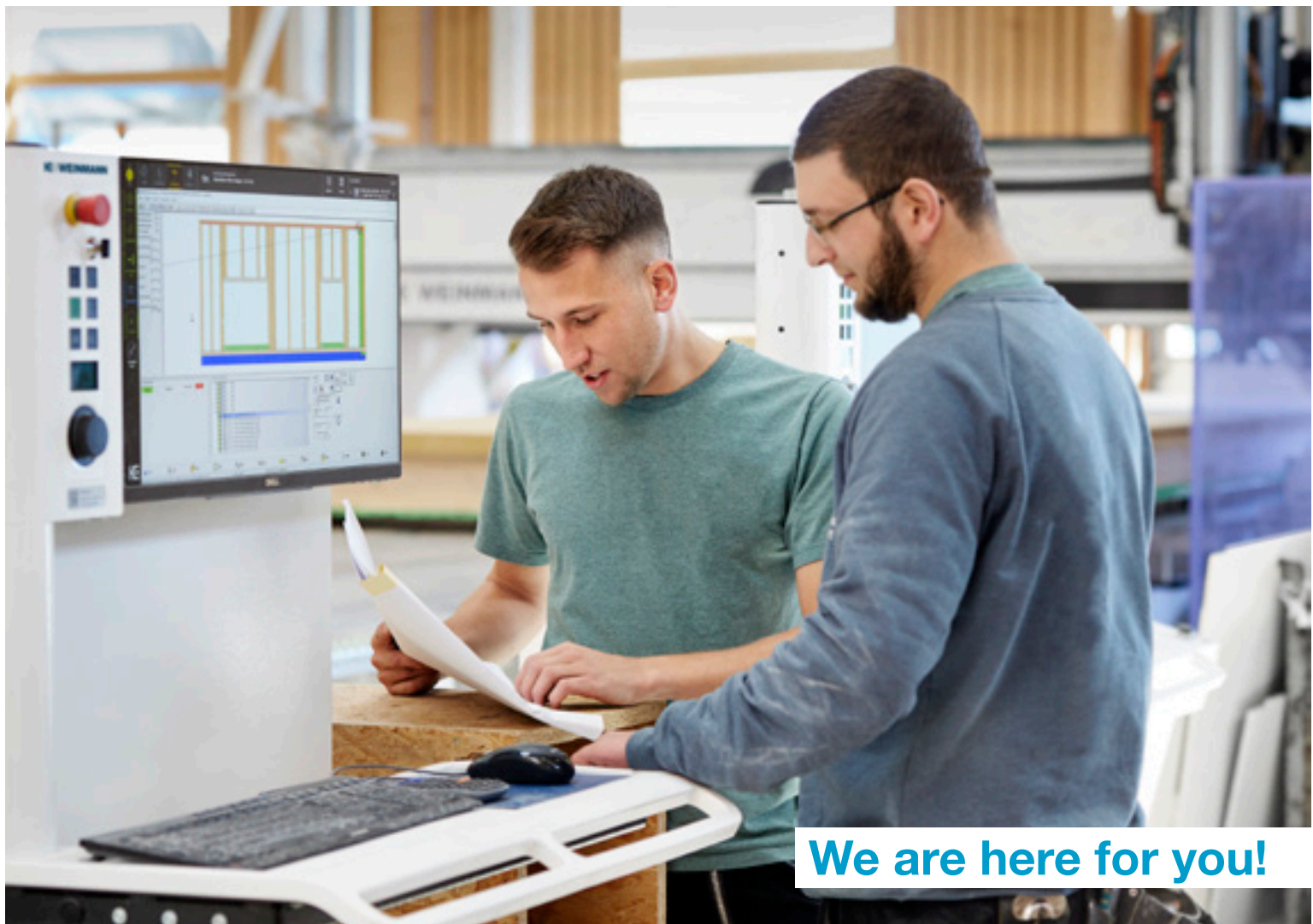

We are here for you!

SCHULER Consulting:

Strategies for practice

SHAPING THE FUTURE TOGETHER.

We want to shape the future of your company together with you. Set you up perfectly and lead you to success. Because only those who recognize opportunities, define the right means and also implement them consistently will be rewarded. Review the existing, question the tried

and tested, and sometimes break new ground. This is how the future works today. For this, we at WEINMANN have Schuler Consulting, probably the strongest partner based on industry know-how, at our side and directly accessible to you.



OUR APPROACH

orienting

focusing

realizing

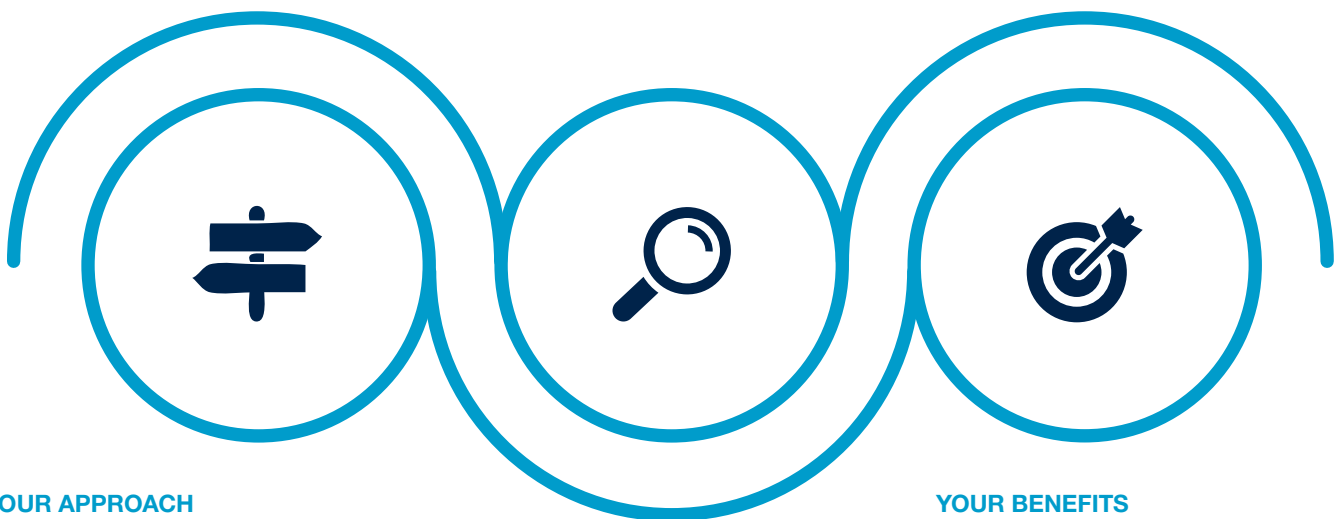

OUR APPROACH

What is the state of your business today?

POSSIBLE FOCUS

Which optimisation potentials are there?

YOUR BENEFITS

What takes priority?



SCHULER COMPANY ECG:

The right strategy for your future.

What we offer you? No one-size-fits-all solutions! Every company is unique, the challenges it faces are diverse. Changes in the market leave no company untouched.

If you want to keep up, you have to act.

For timber construction, this means streamlining and optimizing processes, automating and digitizing. But where do you start? Feel free to contact us!

LEAN PRODUCTION:

Practical example: Improvements in material flow



INFO

SCHULER
Contact form

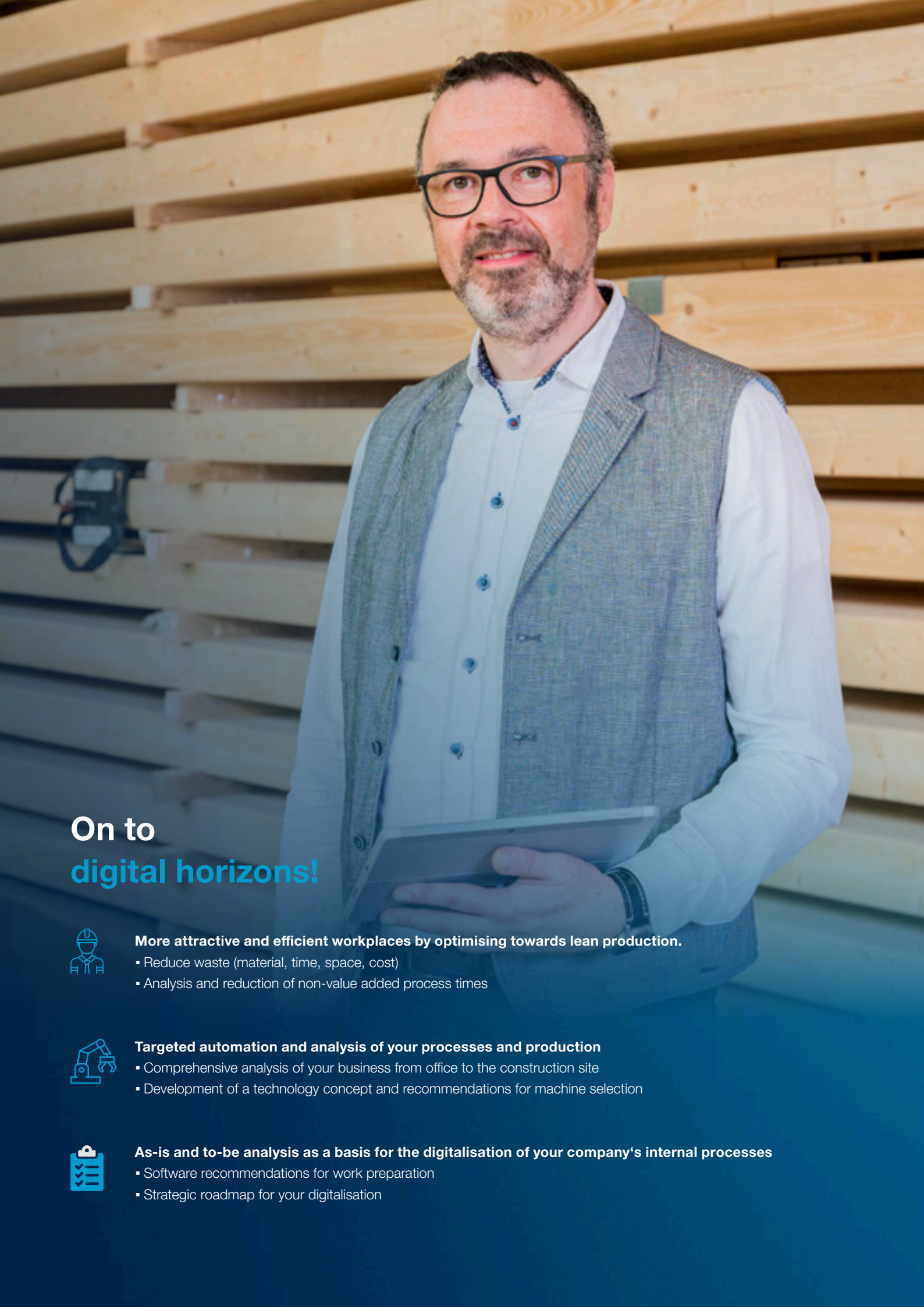

On to digital horizons!



More attractive and efficient workplaces by optimising towards lean production.

- Reduce waste (material, time, space, cost)
- Analysis and reduction of non-value added process times



Targeted automation and analysis of your processes and production

- Comprehensive analysis of your business from office to the construction site
- Development of a technology concept and recommendations for machine selection



As-is and to-be analysis as a basis for the digitalisation of your company's internal processes

- Software recommendations for work preparation
- Strategic roadmap for your digitalisation



Digitalisation in timber construction:

Getting focused and successful

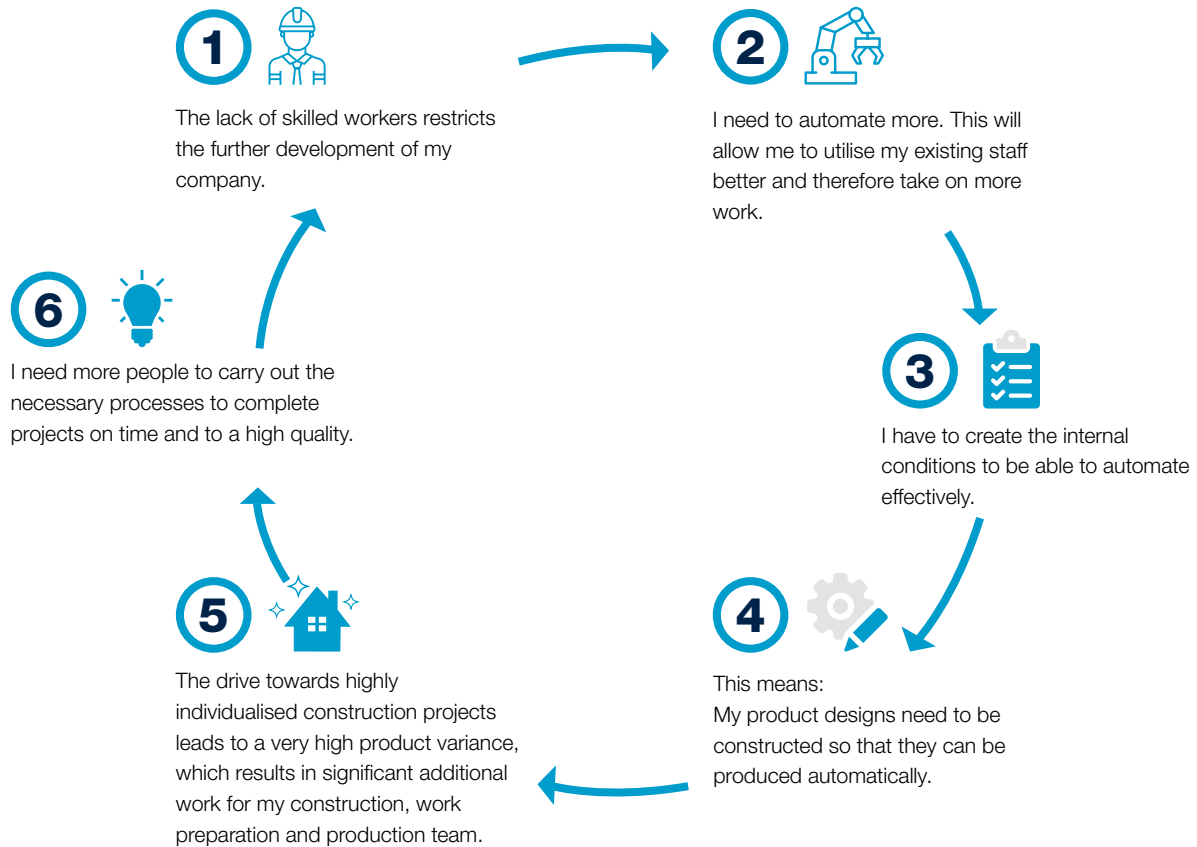

We will analyse the relevant core processes in your organisation and provide you with targeted recommendations on how to break the vicious cycle of labour shortages. Together, we pave the way for meaningful digitalisation and automation. The result? You gain competitive advantages in productivity, efficiency and quality and create attractive workplaces in your company.



Recommendations for structuring and optimising your products

- Recommendations for improving and standardising your designs to increase automation and production efficiency



Support for product standardisation

- Recommendations for:
 - Construction of wall, roof and ceiling structures
 - Window and door openings
 - Component variety and dimensions



Automation and digitalisation know-how:

- Advice on the appropriate level of digitalisation and automation.
(Where do I need to digitise? Where does automation make sense?)



WEINMANN Holzbausystemtechnik GmbH

info@weinmann-partner.de
www.homag.com/weinmann

YOUR SOLUTION